



Fitgenix
Life Time Fitness



CARDIO ***SERIES***



Fitgenix
Life Time Fitness

HEAVY COMMERCIAL TREADMILL

FG 5012



Maximum Horse Power	5.8 HP
Incline	0 - 18 %
Speed	1 - 20 kmph
Net weight	200 kgs
Gross weight	270 kgs
Maximum user weight	150 kgs
Screen	LED Display
Dimension	220 cm (L) * 92 cm (W) * 154 cm (H)
Running area	162 cm * 58 cm
Other Functions	MP3 Player

COMMERCIAL TREADMILL

FG 5013



Maximum Horse Power	5.3 HP
Incline	0 - 18 %
Speed	1 - 25 kmph
Net weight	210 kgs
Gross weight	320 kgs
Maximum user weight	182 kgs
Screen	LED Display
Dimension	229 cm (L) * 100 cm (W) * 155 cm (H)
Running area	162 cm * 58 cm
Other Functions	MP3 Player

LED COMMERCIAL TREADMILL

FG 5023



Maximum Horse Power	4.5 HP
Incline	0 - 16 %
Speed	1 - 25 kmph
Net weight	190 kgs
Gross weight	230 kgs
Maximum user weight	150 kgs
Screen	LED Screen
Dimension	220 cm (L) * 85 cm (W) * 151 cm (H)
Running area	155 cm * 55 cm
Running Belt	2.2 mm

LED ELLIPTICAL FG 5024



Stride Length	500 - 580 mm
Net weight	200 kgs
Gross weight	240 kgs
Maximum user weight	150 kgs
Screen	LED Screen
Dimension	221 cm (L) * 73 cm (W) * 165 cm (H)
Control	Electric Magnetic control
Drive	Rear Drive

LED ELLIPTICAL FG 5025



Rod	Dual Grid Rod
Additional feature	Electric Incline
Stride Length	500 - 580 mm
Net weight	200 kgs
Gross weight	240 kgs
Maximum user weight	150 kgs
Screen	LED Screen
Dimension	221 cm (L) * 73 cm (W) * 165 cm (H)
Control	Electric Magnetic control
Drive	Rear Drive

LED CLIMBER

FG 5026

Net weight	110 kgs
Gross weight	160 kgs
Maximum user weight	150 kgs
Screen	LED Screen
Dimension	91 cm (L) * 132 cm (W) * 180 cm (H)
Control	Speed Electric Resistance control



UPRIGHT CYCLE

FG 5027

Net weight	72 kgs
Gross weight	92 kgs
Maximum user weight	150 kgs
Screen	LED Screen
Dimension	120 cm (L) * 58 cm (W) * 155 cm (H)
Wheel	15 kgs
Resistance	1 - 20 grade



RECUMBENT BIKE

FG 5028

Net weight	98 kgs
Gross weight	135 kgs
Maximum user weight	150 kgs
Screen	LED Screen
Dimension	177 cm (L) * 75 cm (W) * 145 cm (H)
Wheel	15 kgs
Resistance	1 - 20 grade



SPINNING BIKE

FG 5009



Control	Magnetic Brake Control
Fly wheel	15 kgs
Drive	Belt Drive
Seat	CI-3017A
Pedal	SPD
Bottom Bracket	UN-55
Crank	#800

SPINNING BIKE

FG 5010



Brake System	Motorized Magnetic
Computer	Time, Speed, Distance, RPM Pulse Calories, H.R.C, Watt, Bluetooth
Net Weight	59 Kg
Gross Weight	63 Kg
Fly Wheel	22 kgs
Extra	Water Bottle Holder

SPINNING BIKE

FG 5011



Brake System	Friction
Computer	Time, Speed, Distance, Pulse ,Calories,
Net Weight	46 Kg
Gross Weight	51 Kg
Fly Wheel	23 kgs

AIR BIKE BIKE

FG 5022

Machine Size	125 * 54 * 120 cm
Net Weight	49 kgs
Gross Weight	56 kgs
Drive System	V-belt
Fan Size	27 inch of refined steel
Function	Time, Distance, Calorie, Speed
Screen	LCD
Handle	Multifunction Handle
Other Functions	Water Bottle cage Mobile Phone Support High bounce comfort cushion Precision



STAIR MASTER

FG 5006



Console Screen	0.56" Led + 8x8 Dot Matrix
Resistance	20 Levels
Staircase Dimension	55 x 27 x 20 cm
Gross Weight	226 / 310 kg
Maximum user weight	180 kgs

CURVE TREADMILL

FG 5014



Running belt size	170 x 44 cm (HxW)
Treadmill size	227 x 85 x 150 cm (LxWxH)
Speed	Unlimited
Net weight	165 kgs
Gross weight	220 kgs
*Zero - Energy Consumption	
Pure green energy Treadmill	

CURVE TREADMILL

FG 5015



Running belt size	170 x 44 cm (HxW)
Treadmill size	199 x 85 x 150 cm (LxWxH)
Speed	Unlimited
Net weight	165 kgs
Gross weight	220 kgs
*Zero - Energy Consumption	
*Pure green energy Treadmill	

ROWER

FG 5016



Max User weight	150 kgs
Dimensions	2720x525x110 (LxWxH)
Machine weight	52.4 kgs

CLIMBER

FG 5017



Movement Distance	Up & Down 500 mm
Assembly Size	1200x1250x2380 (LxWxH)
Net Weight	140 kgs
Incline Angle	75°
Max Loading Weight	150 kg
Resistance Level	8 Levels



Fitgenix
Life Time Fitness



FG 4000 SERIES

SEATED CHEST PRESS

FG 4001



Stack Weight (KG)	109
Machine Weight (KG)	187
Specification	Main Tube: 50 x100 elliptical
Length mm	1555
Width mm	985
Height mm	1815
Cable	Steel cable, 4,8 diameter, Max loading:10000N-15000N

Frame Color

-  Black
-  Silver

Upholstery

-  Black
-  Red
-  Orange

CHEST PRESS / SHOULDER PRESS



FG 4002



Frame Color

-  Black
-  Silver

Upholstery

-  Black
-  Red
-  Orange

Stack Weight (KG)	122
Machine Weight (KG)	248
Specification	Main Tube: 50 x100 elliptical
Length mm	1984
Width mm	1350
Height mm	1676
Cable	Steel cable, 4.8 diameter, Max loading:10000N-15000N





PEG FLY / REAR DELT

FG 4003

Frame Color

-  Black
-  Silver

Upholstery

-  Black
-  Red
-  Orange

Stack Weight (KG)	114
Machine Weight (KG)	193
Specification	Main Tube: 50 x100 elliptical
Length mm	1451
Width mm	1463
Height mm	1985
Cable	Steel cable, 4.8 diameter, Max loading:10000N-15000N



WIDE CHEST FLY / SIDE LATERAL RAISE

FG 4004

Frame Color

-  Black
-  Silver

Upholstery

-  Black
-  Red
-  Orange

Stack Weight (KG)	80 / 109
Machine Weight (KG)	179
Specification	Main Tube: 50 x100 elliptical
Length mm	1530
Width mm	710
Height mm	1567
Cable	Steel cable, 4.8 diameter, Max loading:10000N-15000N



SHOULDER PRESS

FG 4005



Stack Weight (KG)	183
Machine Weight (KG)	109
Specification	Main Tube: 50 x100 elliptical
Length mm	1707
Width mm	1459
Height mm	1500
Cable	Steel cable, 4.8 diameter, Max loading:1.0000N-15000N

Frame Color

-  Black
-  Silver

Upholstery

-  Black
-  Red
-  Orange



SEATED LATERAL RAISE

FG 4006

Frame Color

-  Black
-  Silver

Upholstery

-  Black
-  Red
-  Orange

Stack Weight (KG)	100
Machine Weight (KG)	188
Specification	Main Tube: 50 x100 elliptical
Length mm	1506
Width mm	984
Height mm	1500
Cable	Steel cable, 4.8 diameter, Max loading:10000N-15000N



DIP/CHIN ASSIST

FG 4007



Stack Weight (KG)	114
Machine Weight (KG)	228
Specification	Main Tube: 50 x100 elliptical
Length mm	1238
Width mm	1187
Height mm	2236
Cable	Steel cable, 4.8 diameter, Max loading:10000N-15000N

Frame Color

-  Black
-  Silver

Upholstery

-  Black
-  Red
-  Orange

HIGH PULLDOWN FG 4008



Stack Weight (KG)	114
Machine Weight (KG)	199
Specification	Main Tube: 50 x100 elliptical
Length mm	1475
Width mm	1213
Height mm	2303
Cable	Steel cable, 4.8 diameter, Max loading:10000N-15000N

Frame Color

-  Black
-  Silver

Upholstery

-  Black
-  Red
-  Orange



LAT PULLDOWN

FG 4009

Frame Color

-  Black
-  Silver

Upholstery

-  Black
-  Red
-  Orange

Stack Weight (KG)	136
Machine Weight (KG)	310
Specification	Main Tube: 50 x100 elliptical
Length mm	1675
Width mm	1430
Height mm	2020
Cable	Steel cable, 4.8 diameter, Max loading:10000N-15000N



SEATED ROW

FG 4010



Stack Weight (KG)	188
Machine Weight (KG)	114
Specification	Main Tube: 50 x100 elliptical
Length mm	1590
Width mm	1115
Height mm	1500
Cable	Steel cable, 4.8 diameter, Max loading:10000N-15000N

Frame Color

-  Black
-  Silver

Upholstery

-  Black
-  Red
-  Orange

LAT PULLDOWN / SEATED ROW

FG 4011



Frame Color

-  Black
-  Silver

Upholstery

-  Black
-  Red
-  Orange

Stack Weight (KG)	114
Machine Weight (KG)	233
Specification	Main Tube: 50 x100 elliptical
Length mm	1808
Width mm	1213
Height mm	2280
Cable	Steel cable, 4.8 diameter, Max loading:10000N-15000N





SEATED LOW ROW

FG 4012

Frame Color

-  Black
-  Silver

Upholstery

-  Black
-  Red
-  Orange

Stack Weight (KG)	123
Machine Weight (KG)	213
Specification	Main Tube: 50 x100 elliptical
Length mm	1480
Width mm	1020
Height mm	1853
Cable	Steel cable, 4.8 diameter, Max loading:10000N-15000N



PULLDOWN / ROW

FG 4013



Frame Color

-  Black
-  Silver

Upholstery

-  Black
-  Red
-  Orange

Stack Weight (KG)	100
Machine Weight (KG)	165
Specification	Main Tube: 50 x100 elliptical
Length mm	709
Width mm	1492
Height mm	2104
Cable	Steel cable, 4.8 diameter, Max loading:10000N-15000N



SINGLE ADJUSTABLE PULLEY

FG 4014



Frame Color

-  Black
-  Silver

Upholstery

-  Black
-  Red
-  Orange

Stack Weight (KG)	100
Machine Weight (KG)	139
Specification	Main Tube: 50 x100 elliptical
Length mm	1280
Width mm	710
Height mm	2321
Cable	Steel cable, 4.8 diameter, Max loading:10000N-15000N



BICEPS CURL

FG 4015



Stack Weight (KG)	109
Machine Weight (KG)	159
Specification	Main Tube: 50 x100 elliptical
Length mm	1255
Width mm	1085
Height mm	1500
Cable	Steel cable, 4.8 diameter, Max loading:10000N-15000N

Frame Color

-  Black
-  Silver

Upholstery

-  Black
-  Red
-  Orange

TRICEPS EXTENSION

FG 4016



Stack Weight (KG)	86
Machine Weight (KG)	165
Specification	Main Tube: 50 x100 elliptical
Length mm	1245
Width mm	1020
Height mm	1500
Cable	Steel cable, 4.8 diameter, Max loading:10000N-15000N

Frame Color

-  Black
-  Silver

Upholstery

-  Black
-  Red
-  Orange





BICEPS CURL / TRICEPS EXTENSION

FG 4017

Frame Color

-  Black
-  Silver

Upholstery

-  Black
-  Red
-  Orange

Stack Weight (KG)	100
Machine Weight (KG)	182
Specification	Main Tube: 50 x100 elliptical
Length mm	1239
Width mm	1305
Height mm	1580
Cable	Steel cable, 4.8 diameter, Max loading:10000N-15000N



LEG EXTENSION

FG 4018



Stack Weight (KG)	114
Machine Weight (KG)	214
Specification	Main Tube: 50 x100 elliptical
Length mm	1475
Width mm	1260
Height mm	1500
Cable	Steel cable, 4.8 diameter, Max loading:10000N-15000N

Frame Color

-  Black
-  Silver

Upholstery

-  Black
-  Red
-  Orange

SEATED LEG CURL

FG 4019



Stack Weight (KG)	114
Machine Weight (KG)	212
Specification	Main Tube: 50 x100 elliptical
Length mm	1455
Width mm	1265
Height mm	1500
Cable	Steel cable, 4.8 diameter, Max loading:10000N-15000N

Frame Color

-  Black
-  Silver

Upholstery

-  Black
-  Red
-  Orange



PRONE LEG CURL

FG 4020

Frame Color

-  Black
-  Silver

Upholstery

-  Black
-  Red
-  Orange

Stack Weight (KG)	104
Machine Weight (KG)	194
Specification	Main Tube: 50 x100 elliptical
Length mm	1725
Width mm	1278
Height mm	1500
Cable	Steel cable, 4.8 diameter, Max loading:10000N-15000N



LEG EXTENSION / LEG CURL

FG 4021

Frame Color

-  Black
-  Silver

Upholstery

-  Black
-  Red
-  Orange

Stack Weight (KG)	132
Machine Weight (KG)	274
Specification	Main Tube: 50 x100 elliptical
Length mm	1407
Width mm	1249
Height mm	1496
Cable	Steel cable, 4,8 diameter, Max loading:10000N-15000N





ABDUCTOR / ADDUCTOR

FG 4022

Frame Color

-  Black
-  Silver

Upholstery

-  Black
-  Red
-  Orange

Stack Weight (KG)	104
Machine Weight (KG)	190
Specification	Main Tube: 50 x100 elliptical
Length mm	1617
Width mm	677
Height mm	1500
Cable	Steel cable, 4.8 diameter, Max loading:10000N-15000N





GLUTE ISOLATOR

FG 4023

Frame Color

-  Black
-  Silver

Upholstery

-  Black
-  Red
-  Orange

Stack Weight (KG)	123
Machine Weight (KG)	213
Specification	Main Tube: 50 x100 elliptical
Length mm	2160
Width mm	1000
Height mm	1500
Cable	Steel cable, 4.8 diameter, Max loading:10000N-15000N





STANDING CALF RAISE

FG 4024

Frame Color

-  Black
-  Silver

Upholstery

-  Black
-  Red
-  Orange

Stack Weight (KG)	104
Machine Weight (KG)	205
Specification	Main Tube: 50 x100 elliptical
Length mm	1054
Width mm	955
Height mm	1656
Cable	Steel cable, 4.8 diameter, Max loading:10000N-15000N



DEEP SQUAT/STANDING CALF RAISE

FG 4025



Stack Weight (KG)	150
Machine Weight (KG)	166
Specification	Main Tube: 50 x100 elliptical
Length mm	1332
Width mm	1170
Height mm	1513
Cable	Steel cable, 4.8 diameter, Max loading:1 0000N-1 5000N

Frame Color

-  Black
-  Silver

Upholstery

-  Black
-  Red
-  Orange

LEG PRESS/CALF EXTENSION

FG 4026



Frame Color

-  Black
-  Silver

Upholstery

-  Black
-  Red
-  Orange

Stack Weight (KG)	168
Machine Weight (KG)	297
Specification	Main Tube: 50 x100 elliptical
Length mm	1940
Width mm	1135
Height mm	1580
Cable	Steel cable, 4.8 diameter, Max loading:10000N-15000N



SEATED LEG PRESS

FG 4027



Stack Weight (KG)	150
Machine Weight (KG)	330
Specification	Main Tube: 50 x100 elliptical
Length mm	1864
Width mm	1184
Height mm	1500
Cable	Steel cable, 4.8 diameter, Max loading:10000N-15000N

Frame Color

-  Black
-  Silver

Upholstery

-  Black
-  Red
-  Orange

HIP THRUST FG 4028



Stack Weight (KG)	104
Machine Weight (KG)	190
Specification	Main Tube: 50 x100 elliptical
Length mm	1624
Width mm	1172
Height mm	1496
Cable	Steel cable, 4.8 diameter, Max loading:10000N-15000N

Frame Color

-  Black
-  Silver

Upholstery

-  Black
-  Red
-  Orange



ROTARY HIP

FG 4029

Frame Color

-  Black
-  Silver

Upholstery

-  Black
-  Red
-  Orange

Stack Weight (KG)	100
Machine Weight (KG)	219
Specification	Main Tube: 50 x100 elliptical
Length mm	1606
Width mm	1403
Height mm	990
Cable	Steel cable, 4.8 diameter, Max loading:10000N-15000N



WAIST SIDE BENDING

FG 4030



Frame Color

-  Black
-  Silver

Upholstery

-  Black
-  Red
-  Orange

Stack Weight (KG)	100
Machine Weight (KG)	148
Specification	Main Tube: 50 x100 elliptical
Length mm	1360
Width mm	707
Height mm	1495
Cable	Steel cable, 4.8 diameter, Max loading:10000N-15000N









NECK BENDING MACHINE

FG 4031

Frame Color

-  Black
-  Silver

Upholstery

-  Black
-  Red
-  Orange

Stack Weight (KG)	100
Machine Weight (KG)	208
Specification	Main Tube: 50 x100 elliptical
Length mm	1720
Width mm	710
Height mm	1578
Cable	Steel cable, 4.8 diameter, Max loading:10000N-15000N



NECK ROTATION

FG 4032



Frame Color

-  Black
-  Silver

Upholstery

-  Black
-  Red
-  Orange

Stack Weight (KG)	100
Machine Weight (KG)	116
Specification	Main Tube: 50 x100 elliptical
Length mm	1375
Width mm	1100
Height mm	1870
Cable	Steel cable, 4.8 diameter, Max loading:10000N-15000N





TORSO ROTATION

FG 4033



Stack Weight (KG)	155
Machine Weight (KG)	80
Specification	Main Tube: 50 x100 elliptical
Length mm	1077
Width mm	815
Height mm	1500
Cable	Steel cable, 4.8 diameter, Max loading:10000N-15000N

Frame Color

-  Black
-  Silver

Upholstery

-  Black
-  Red
-  Orange

TORSO ROTATION

FG 4034



Frame Color

-  Black
-  Silver

Upholstery

-  Black
-  Red
-  Orange

Stack Weight (KG)	100
Machine Weight (KG)	248
Specification	Main Tube: 50 x100 elliptical
Length mm	1538
Width mm	1187
Height mm	2010
Cable	Steel cable, 4.8 diameter. Max loading:10000N-15000N



ABDOMINAL FG 4035



Stack Weight (KG)	90
Machine Weight (KG)	201
Specification	Main Tube: 50 x100 elliptical
Length mm	900
Width mm	1210
Height mm	1500
Cable	Steel cable, 4.8 diameter, Max loading:10000N-15000N

Frame Color

-  Black
-  Silver

Upholstery

-  Black
-  Red
-  Orange

BACK EXTENSION

FG 4036



Stack Weight (KG)	90
Machine Weight (KG)	207
Specification	Main Tube: 50 x100 elliptical
Length mm	1223
Width mm	1219
Height mm	1500
Cable	Steel cable, 4.8 diameter, Max loading:10000N-15000N

Frame Color

-  Black
-  Silver

Upholstery

-  Black
-  Red
-  Orange

ABDOMINAL / BACK EXTENSION

FG 4037

Frame Color

-  Black
-  Silver

Upholstery

-  Black
-  Red
-  Orange

Stack Weight (KG)	120
Machine Weight (KG)	225
Specification	Main Tube: 50 x100 elliptical
Length mm	1314
Width mm	1199
Height mm	1580
Cable	Steel cable, 4.8 diameter, Max loading:10000N-15000N



DUAL CABLE CROSS

FG 6054

Stack Weight (KG)	---
Machine Weight (KG)	170
Specification	---
Length mm	3380
Width mm	1600
Height mm	2410



DUAL CABLE CROSS

FG 9005

Stack Weight (lbs)	2 X 79 lbs
Machine Weight (KG)	103
Specification	---
Length mm	1869
Width mm	1724
Height mm	2300



CABLE CROSS OVER

FG 4038

Stack Weight (KG)	91 x 2 kg
Machine Weight (KG)	132
Max User Weight (KG)	180
Length mm	840
Width mm	1520
Height mm	2120



PULLEY COMBO

FG 4039

Stack Weight (KG)	70 x 2 (140) kg
Net Weight (KG)	293
Max User Weight (KG)	180
Length mm	4091
Width mm	1065
Height mm	2344



4 STATION

FG 6052

Stack Weight (KG)	---
Machine Weight (KG)	320
Specification	Main frame 50 x 100 x 3
Length mm	3450
Width mm	1950
Height mm	2300



5 STATION FG 6055



Stack Weight (KG)	---
Machine Weight (KG)	470
Specification	Main frame 50 x 100 x 3 elliptical
Length mm	5100
Width mm	3450
Height mm	2300

8 STATION FG 6053



Stack Weight (KG)	---
Machine Weight (KG)	670
Specification	Main frame 50 x 100 x 3
Length mm	5900
Width mm	4100
Height mm	2300

8 STATION GYM

FG 6023



Stack Weight (KG)	---
Machine Weight (KG)	---
Specification	Main frame 50 x 100 x 3.0 mm
Length mm	5900
Width mm	4100
Height mm	2300

CHIN DIP LEG RAISE

FG 6047

Stack Weight (KG)	---
Machine Weight (KG)	---
Specification	Main frame 120 x 40 x t 2.0
Length mm	1310
Width mm	1370
Height mm	2165





 *Fitgenix*
Life Time Fitness

FG 7000
SERIES

 *Fitgenix*
Life Time Fitness

CHEST & DECLINE COMBO

FG 7001



Main Tube Size	100 x 50x3.0mm Flat Oval Tube
Assembly Size (mm)	1605 x 1602 x 1471
Net weight	185.5 kgs
Gross Weight	194.5 kgs
One-touch Chair Adjustment	

 **Fitgenix**
Life Time Fitness

INCLINE CHEST PRESS

FG 7002



Main Tube Size	100 x 50x3.0mm Flat Oval Tube
Assembly Size (mm)	1809 x 1716 x 1440
Net weight	249 kgs
Gross Weight	263 kgs
One-touch Chair Adjustment	

WIDE PULL DOWN (Rear)

FG 7003



Main Tube Size	100 x 50x3.0mm Flat Oval Tube
Assembly Size (mm)	1780 x 1404 x 2050
Net weight	171 kgs
Gross Weight	187 kgs
One-touch Chair Adjustment	

NARROW PULL DOWN

FG 7004



Main Tube Size	100 x 50x3.0mm Flat Oval Tube
Assembly Size (mm)	1820 x 1404 x 1987
Net weight	184 kgs
Gross Weight	198 kgs
One-touch Chair Adjustment	

LAT PULL DOWN

FG 7005



Main Tube Size	100 x 50x3.0mm Flat Oval Tube
Assembly Size (mm)	1990 x 1600 x 1300
Net weight	260.5 kgs
Gross Weight	283 kgs

LOW ROW

FG 7006



Main Tube Size	100 x 50x3.0mm Flat Oval Tube
Assembly Size (mm)	1473 x 1345 x 1447
Net weight	186 kgs
Gross Weight	204 kgs

SEATED ROW

FG 7007



Main Tube Size	100 x 50x3.0mm Flat Oval Tube
Assembly Size (mm)	1555 x 1097 x 1352
Net weight	124 kgs
Gross Weight	134 kgs
One-touch Chair Adjustment	

SHOULDER PRESS

FG 7008



Main Tube Size	100 x 50x3.0mm Flat Oval Tube
Assembly Size (mm)	1880 x 1687 x 1268
Net weight	238 kgs
Gross Weight	253 kgs

SEATED ABDOMINAL

FG 7009



Main Tube Size	100 x 50x3.0mm Flat Oval Tube
Assembly Size (mm)	1250 x 1050 x 700
Net weight	117.5 kgs
Gross Weight	---

SEATED BICEPS

FG 7010



Main Tube Size	100 x 50x3.0mm Flat Oval Tube
Assembly Size (mm)	1600 x 1180 x 400
Net weight	226 kgs
Gross Weight	---

SEATED TRICEPS

FG 7011



Main Tube Size	100 x 50x3.0mm Flat Oval Tube
Assembly Size (mm)	1840 x 1070 x 530
Net weight	195 kgs
Gross Weight	---

LEG PRESS BACK

FG 7012



Main Tube Size	100 x 50x3.0mm Flat Oval Tube
Assembly Size (mm)	1520 x 1350 x 450
Net weight	155 kgs
Gross Weight	205 kgs

KNEELING LEG CURL

FG 7013



Main Tube Size	100 x 50x3.0mm Flat Oval Tube
Assembly Size (mm)	1380 x 1450 x 1300
Net weight	123.5 kgs
Gross Weight	133 kgs

LEG EXTENSION

FG 7014



Main Tube Size	100 x 50x3.0mm Flat Oval Tube
Assembly Size (mm)	1466 x 1423 x 1100
Net weight	138 kgs
Gross Weight	147 kgs

SQUAT

FG 7015



Main Tube Size	100 x 50x3.0mm Flat Oval Tube
Assembly Size (mm)	1850 x 960 x 660
Net weight	173 kgs
Gross Weight	215 kgs

AB CRUNCH

FG 7016



Main Tube Size	100 x 50x3.0mm Flat Oval Tube
Assembly Size (mm)	1400 x 1150 x 1400
Net weight	244 kgs
Gross Weight	317 kgs

45° LEG PRESS

FG 7017



Main Tube Size	100 x 50x3.0mm Flat Oval Tube
Assembly Size (mm)	1511 x 1180 x 1337
Net weight	134 kgs
Gross Weight	189 kgs

PENDULUM SQUAT

FG 7018

Frame Color

-  Black
-  Silver

Upholstery

-  Black
-  Red
-  Orange

Stack Weight (KG)	Max Loading: 90kg*2 (Front balance holer max 80kgs)
Specification	Main Rectangle Tube: J50*80*3 Weight plate holder size: 48*3*280, Dead load: 22kgs
Machine Weight (KG)	120
Length mm	2136
Width mm	1629
Height mm	960



HIP THRUST

FG 7019

Frame Color

- Black
- Silver

Upholstery

- Black
- Red
- Orange



Stack Weight (KG)	Max Loading: 100kg*2
Specification	Main Rectangle Tube: 70*140*4 & 150*80*3, Container loading: 30/ 60/60 pcs
Machine Weight (KG)	89
Length mm	1625
Width mm	1249
Height mm	815



45° LEG PRESS

FG 7020

Frame Color

-  Black
-  Silver

Upholstery

-  Black
-  Red
-  Orange

Stack Weight (KG)	Max Loading: 100kg*2
Specification	Main Rectangle Tube: 70*140*4 & J50*80*3, Container loading: 30/ 60/60 pcs
Machine Weight (KG)	89
Length mm	1625
Width mm	1249
Height mm	815



ANGLED LEG PRESS

FG 6049



Main Frame	50 x 150 x t2.0
Length mm	2050
Width mm	1000
Height mm	1469



PLATE LOADED SQUAT PRESS

FG 9007



Machine Weight (KG)	229 kg
Length mm	2421
Width mm	1680
Height mm	1572



SEATED CALF

FG 4040

Main frame size Circular (mm)	50 x 70 x 2.5 mm
Main frame size Rectangular (mm)	76 x 2.5 mm
Net Weight (KG)	54 kg
Max User Weight	180 kg
Length mm	1388
Width mm	617
Height mm	942





FG 8000 SERIES



CHEST PRESS

FG 8000



Maximum Weight (KG)	150 kg * 2
Machine Weight (KG)	150 kg
Length mm	1956
Width mm	1097
Height mm	1178

ROW

FG 8001



Maximum Weight (KG)	150 kg * 2
Machine Weight (KG)	150 kg
Length mm	1471
Width mm	1365
Height mm	1251



SHOULDER PRESS

FG 8002



Maximum Weight (KG)	150 kg * 2
Machine Weight (KG)	148 kg
Length mm	1714
Width mm	1273
Height mm	1259

LAT PULL DOWN

FG 8003



Maximum Weight (KG)	150 kg * 2
Machine Weight (KG)	128 kg
Length mm	1407
Width mm	1839
Height mm	1831

LEG PRESS

FG 8004



Maximum Weight (KG)	200 kg * 2
Machine Weight (KG)	230 kg
Length mm	2173
Width mm	1866
Height mm	1543

PRONE GLUTE KICK BACK

FG 8005



Maximum Weight (KG)	150 kg
Machine Weight (KG)	90 kg
Length mm	1282
Width mm	1422
Height mm	1220

ABDUCTOR / ADDUCTOR

FG 8006



Maximum Weight (KG)	150 kg
Machine Weight (KG)	150 kg
Length mm	1525
Width mm	930
Height mm	1450



◀ **BENCHES**
◀ **RACKS**
◀ **SMITH MACHINES**

OLYMPIC INCLINE BENCH

FG 6029

Specification	120 x 40 x t2,0
Length mm	4070
Width mm	1580
Height mm	1375



OLYMPIC FLAT BENCH

FG 6030



Specification	---
Length mm	1990
Width mm	1580
Height mm	1375

OLYMPIC DECLINE BENCH

FG 6031



Main frame	120 x 40 x t2,0
Length mm	1838
Width mm	1590
Height mm	1185

OLYMPIC MILITARY BENCH

FG 6032



Main frame	120 X 40 X t2.0
Length mm	1610
Width mm	1280
Height mm	1700



ADJUSTABLE DECLINE BENCH

FG 6033

Main frame	120 x 40 x t2,0
Length mm	1838
Width mm	1590
Height mm	1185



ADJUSTABLE DUMBBELL BENCH

FG 6034



Main frame	120 X 40 X t2.0
Length mm	1726
Width mm	604
Height mm	518

FLAT BENCH

FG 6035

Main frame	120 x 40 x t2,0
Length mm	1620
Width mm	600
Height mm	445



ADJUSTABLE BENCH

FG 6036



Main frame	80 X 40 X t2.0
Length mm	1362
Width mm	620
Height mm	440

UTILITY BENCH

FG 6037



Main frame	120 x 40 x t2,0
Length mm	870
Width mm	500
Height mm	778



AB CRUNCH

FG 6038

Main frame	80 X 40 X t2.0
Length mm	1980
Width mm	950
Height mm	1100

BARBELL RACK

FG 6039

Main frame	120 x 40 x t2,0
Length mm	905
Width mm	863
Height mm	1388



SQUAT RACK

FG 6040

Main frame	80 X 40 X t2.0
Length mm	1740
Width mm	1677
Height mm	1894

OLYMPIC WEIGHT TREE

FG 6042

Main frame	120 x 40 x t2,0
Length mm	806
Width mm	707
Height mm	937



ARM CURL BENCH

FG 6043

Main frame	80 X 40 X t2.0
Length mm	1005
Width mm	788
Height mm	1189

BACK EXTENSION

FG 6044

Main frame	120 x 40 x t2,0
Length mm	1115
Width mm	803
Height mm	798



LEG RAISE

FG 6045

Main frame	80 X 40 X t2.0
Length mm	1230
Width mm	880
Height mm	1650

STRECHER

FG 6046



Main frame	120 x 40 x t2,0
Length mm	1392
Width mm	684
Height mm	1174

SISSY SQUAT BENCH

FG 6057

Main frame	---
Length mm	1252
Width mm	750
Height mm	388

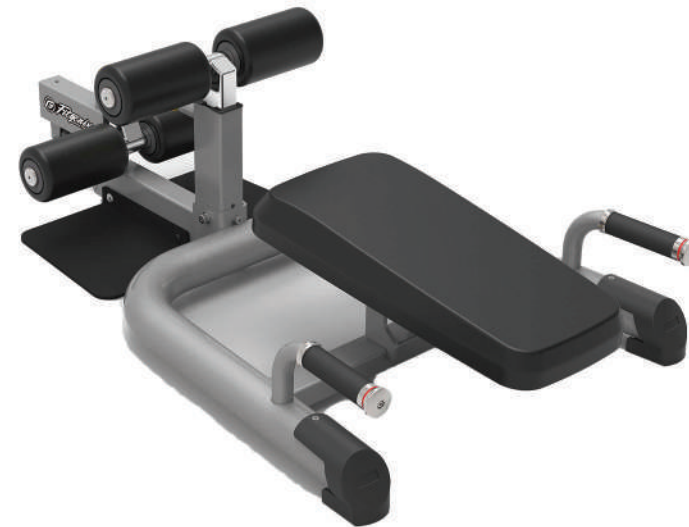

SISSY SQUAT BENCH

FG 6051



Main frame	---
Length mm	1252
Width mm	750
Height mm	388

OLYMPIC FLAT BENCH

FG 9019

Machine weight	79 kg
Length mm	1710
Width mm	1635
Height mm	1296



OLYMPIC INCLINE BENCH

FG 9020

Machine weight	79 kg
Length mm	1800
Width mm	1710
Height mm	1417



OLYMPIC DECLINE BENCH

FG 9021

Machine weight	79 kg
Length mm	---
Width mm	---
Height mm	---



ADJUSTABLE FLAT & DECLINE BENCH

FG 9011

Machine weight	46 kg
Length mm	1465
Width mm	878
Height mm	365

PREACHER CURL

FG 9012

Machine weight	48 kg
Length mm	1047
Width mm	752
Height mm	1019



AB BACK MACHINE

FG 9013

Machine weight	46 kg
Length mm	1354
Width mm	732
Height mm	932

MULTY-PURPOSE FG 9014

Machine weight	37 kg
Length mm	1440
Width mm	732
Height mm	1000



FLAT TO INCLINE UTILITY BENCH FG 9015



Machine weight	42 kg
Length mm	1485
Width mm	672
Height mm	430

ADJUSTABLE UTILITY BENCH

FG 9016

Machine weight	---
Length mm	1480
Width mm	590
Height mm	440



TWO TIER DUMBBELL RACK

FG 6058



Machine weight	63 kg
Length mm	2296
Width mm	643
Height mm	799

TREE RACK

FG 9022

Length mm	791
Width mm	565
Height mm	1210
Packing Size	1165 x 600 x 240 mm
Gross Weight (kg)	31 kgs
Net weight (kg)	28 kgs

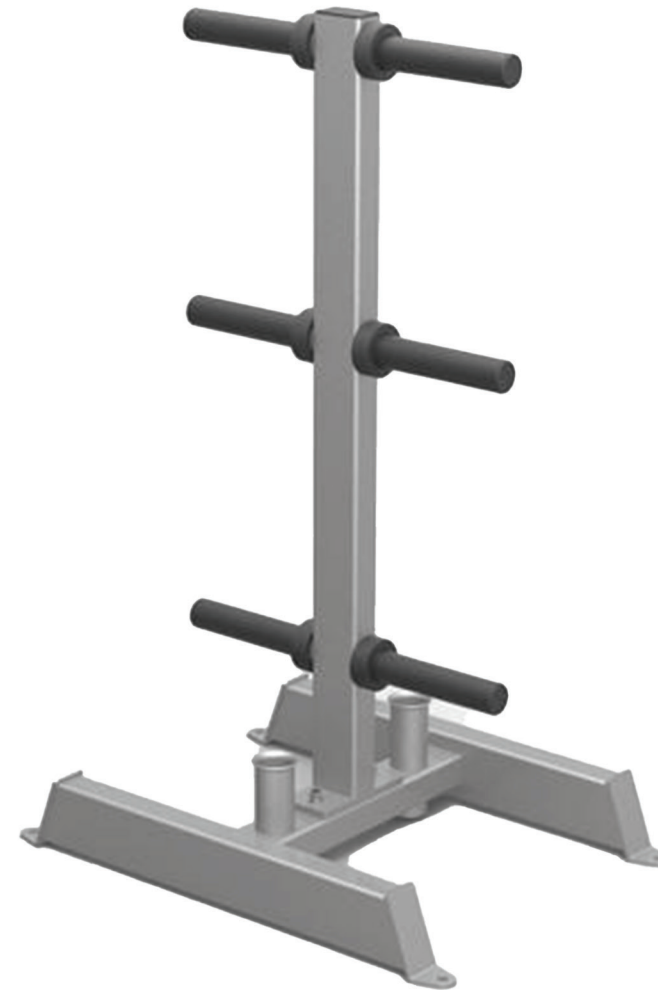

FLAT BENCH

FG 9023



Length mm	1401
Width mm	727
Height mm	452
Net Weight (kg)	27 kgs

HALF POWER RACK

FG 6056



Mechine weight	235 kg
Length mm	1400
Width mm	1500
Height mm	2500

HALF POWER RACK WITH PLATFORM

FG 9000



Machine Weight	553 kg
Length mm	3200
Width mm	3200
Height mm	2500

FULL POWER RACK WITH PLATFORM

FG 9006



Machine Weight	651 kg
Power Rack Shipping Dimension (L,W,H)	1400 x 2100 x 2500
Platform Size (L,W,H)	3200 x 3800 x 60

POWER RACK

FG 9001



Machine Weight	216 kg
Length mm	1869
Width mm	1724
Height mm	2300

FUNCTIONAL GYM

FG 9002

Machine Weight	260 kg
Length mm	2351
Width mm	1367
Height mm	2159
Stack Weight (lb)	240 lb
Stack weight (kg)	260 kg



MULTI FUNCTIONAL SMITH

FG 9003



Length mm	1400
Width mm	2100
Height mm	2280
Gross Weight (kg)	360 kg
Net weight (kg)	325 kg

MULTI FUNCTIONAL SMITH

FG 9004

Length mm	1700
Width mm	2200
Height mm	2230
Gross Weight (kg)	350 kg
Net weight (kg)	315 kg



SMITH MACHINE

FG 9018

Net Weight (KG)	198 kg
Max User Weight (KG)	180 kg
Specification	Main frame 95 x 2.5 mm
Length mm	2165
Width mm	1575
Height mm	2390



BELT SQUAT

FG 9024

Frame Color

- Black
- Silver

Stack Weight (KG)	Max Loading: 175kg*2
Specification	Main Rectangle Tube: J50*80*3 Weight plate holder size: Ø48*3*405 Dead load: 20kgs
Machine Weight (KG)	120
Length mm	1712
Width mm	1751
Height mm	1432



SQUAT RACK

FG 9025

Frame Color

-  Black
-  Silver

Specification	Free Weight
Machine Weight (KG)	130
Length mm	1860
Width mm	1650
Height mm	2010



CHIN DIP LEG RAISE STAND

FG 9026

Frame Color

Upholstery



Black



Black



Silver



Red



Orange

Specification	Free Weight
Machine Weight (KG)	85
Length mm	1258
Width mm	1190
Height mm	2295



FLAT INCLINE DECLINE ADJUSTABLE BENCH

FG 9027

Frame Color

Upholstery

-  Black
-  Silver
-  Black
-  Red
-  Orange



Specification	Free Weight
Machine Weight (KG)	50
Length mm	1450
Width mm	840
Height mm	510

ADJUSTABLE OLYMPIC BENCH RACK

FG 9028

Frame Color

-  Black
-  Silver

Upholstery

-  Black
-  Red
-  Orange

Specification	3 positions : incline, decline, Flat
Machine Weight (KG)	120
Length mm	2250
Width mm	1570
Height mm	1400



FLAT TO INCLINE ADJUSTABLE BENCH

FG 9029

Frame Color

-  Black
-  Silver

Upholstery

-  Black
-  Red
-  Orange

Specification	2 positions : incline, Flat
Machine Weight (KG)	36
Length mm	1340
Width mm	447
Height mm	415



STEEL DUMBBELL RACKS FOR 5 PAIR

FG 9030

Weight (KG)	63
Length mm	1210
Width mm	580
Height mm	730



STEEL DUMBBELL RACKS FOR 10 PAIR

FG 9031

Weight (KG)	108
Length mm	2420
Width mm	580
Height mm	730



FIXED STEEL BARBELLS

Available Colors

-  Golden
-  Silver



EZ BARBELLS

Sizes Available

10kg 12.5kg 15kg 17.5kg 20kg,
25kg 30kg 35kg 40kg 45kg 50kg

STRAIGHT BARBELLES

Sizes Available

10kg 12.5kg 15kg 17.5kg 20kg,
25kg 30kg 35kg 40kg 45kg 50kg

Available Colors

-  Golden
-  Silver



STEEL DUMBBELLS

Sizes Available

2.5 Kg 5 Kg 7.5 Kg 10 Kg 12.5 Kg 15 Kg 17.5 Kg 20 Kg 22.5 Kg 25 Kg
27.5 Kg 30 Kg 32.5 Kg 35 Kg 37.5 Kg 40 Kg 42.5 Kg 45 Kg 47.5 Kg 50 Kg
52.5 Kg 55 Kg 57.5 Kg 60 Kg

Available Colors

-  Golden
-  Silver



STEEL WEIGHT PLATES

Sizes Available

2.5 Kg 5 Kg 10 Kg 15 Kg 20 Kg

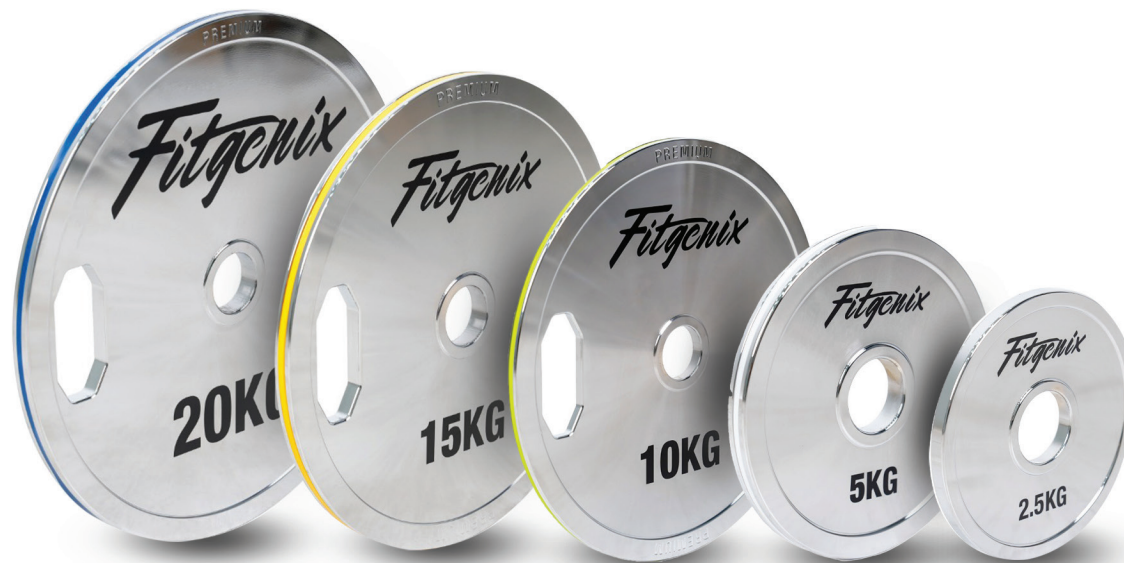

Available Colors

 Silver



**MADE IN
UNITED KINGDOM**



Headquarter Address ; 23 Crowland Road n 15 6UL

MOBILE : +44 7808 835283

www.fitgenix.uk